



# FOLIE



**FS 213**

Porta salvietta ad anello

Towel ring

Anneau porte-serviette

Kreisförmiger Wand-Handtuchhalter

Держатель для полотенец, кольцом



**FS 241**

Appendino

Hook

Porte-peignoir

Wand-Kleiderhaken

Крючок одинарный



## INFORMAZIONI TECNICHE - TECHNICAL INFORMATION - INFORMATIONS TECHNIQUES - TECHNISCHE INFORMATION - ТЕХНИЧЕСКАЯ ИНФОРМАЦИЯ

### COMPONENTI - COMPONENTS - COMPOSANTS - KOMPONENTEN - МАТЕРИАЛЫ

Ottone	Vetro satinato	Cristallo Swarovski®
Brass	Satin glass	Crystal Swarovski®
Laiton	Verre dépoli	Crystal Swarovski®
Messing	SatiniertGlas	SwarovskiCristal®
Латунь	Стекло матовое	Кристаллы Сваровски®

### RICAMBI - SPARE PARTS - PIÈCES DE RECHANGE - ERSATZTEILE - ЗАПАСНЫЕ ЧАСТИ

-  **RI .03**
- RI .11**
- RI .18**
- RI .23**
- RI .27**
- RI .28**
- RI .40**
- FS .47**

















Solo gli articoli indicati possono adattarsi al Kit Idea sostituendo il supporto di fissaggio a muro (vedere pag. 510).  
 Only selected items may be adapted to Kit Idea by replacing the fixing bracket to the wall (see page 510).  
 Seulement les articles sélectionnés peuvent être adaptés au Kit Idea par le remplacement du support de fixation au mur (voir page 510).  
 Nur die aufgeführten Artikel können auf Kit Idea mit der Auswechslung der Halterung (siehe Seite 510).  
 Только указанные аксессуары можно адаптировать к набору Kit Idea, заменив держатель для настенного крепления (см. стр. 510).

Le misure sono in millimetri (mm)  
 Measures are in millimeters (mm)  
 Les mesures sont en millimètres (mm)  
 Die Masse sind in Millimetern (mm)  
 Змерения в миллиметрах (мм)

 Fissaggio a muro  
 Wall fixing  
 Fixation murale  
 Wandbefestigung  
 Крепление к стене

 D'appoggio  
 Standing  
 À poser  
 Ständer  
 Аксессуары настольные

	<p><b>51</b></p>	<p>Cromo Chrome Chrome Chrom Хром</p>		<p><b>03</b></p>	<p>Bianco Opaco Matt white Blanc mat Matt Weiß матовый белый</p>		<p><b>18</b></p>	<p>Nero Opaco Matt black Noir mat Matt Schwarz Матовый чёрный</p>
	<p><b>24</b></p>	<p>Bronzo opaco Matt bronze Bronze mat Matt Bronze Матовая бронза</p>		<p><b>27</b></p>	<p>Ottone spazzolato opaco Matt brushed brass Laiton brossé mat Matt gebürstet Messing Матовая шлифованная латунь</p>		<p><b>50</b></p>	<p>Nichel Nickel Nickel Nickel Никель</p>
	<p><b>52</b></p>	<p>Oro Gold Or Gold Золото</p>		<p><b>55</b></p>	<p>Oro spazzolato Brushed gold Or brossé Gebürstet Gold Шлифованное золото</p>		<p><b>66</b></p>	<p>Rame opaco Matt copper Cuivre mat Matt Kupfer Матовая медь</p>
	<p><b>68</b></p>	<p>Nichel nero spazzolato Brushed black nickel Nickel noir brossé Gebürstet schwarzes Nickel Шлифованный черный никель</p>		<p><b>69</b></p>	<p>Ottone naturale senza protezione Natural brass without protection Laiton naturel sans protection Messing natur ohne Schutz Натуральная латунь без защиты</p>		<p><b>76</b></p>	<p>Nichel nero Black nickel Nickel noir Schwarz Nickel Черный никель</p>
	<p><b>90</b></p>	<p>Nichel spazzolato Brushed nickel Nickel brossé Gebürstet Nickel Шлифованный никель</p>		<p><b>91</b></p>	<p>Rame spazzolato Brushed copper Cuivre brossé Gebürstet Kupfer Шлифованная медь</p>		<p><b>92</b></p>	<p>Bronzo spazzolato Brushed bronze Bronze brossé Gebürstet Bronze Шлифованная бронза</p>

*\*\*rispetto al prezzo del cromo 51 - on the price of chrome 51 - sur le prix du chrome 51 - auf den Preis von Chrom 51 - от цены на хром 51*





**FS 123**

   **RI .03; FS .47**

Porta sapone in vetro satinato  
 Soap holder in satin glass  
 Porte-savon en verre dépoli  
 SatiniertGlas-Wand-Seifenhalter  
 Мыльница в ванную, подвесная, из матового стекла

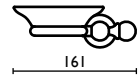
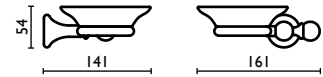

**FS 127**

   **RI .18; RI .40; FS .47**

Porta sapone liquido in vetro satinato  
 Liquid soap dispenser holder in satin glass  
 Porte-diffuseur de savon en verre dépoli  
 SatiniertGlas-Wand-Seifenspender  
 Дозатор для жидкого мыла, настенный, из матового стекла

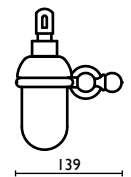
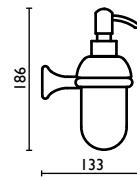

Capacità - Capacity - Capacité -  
 Kapazität - Вместимость: 0,275 lt - л

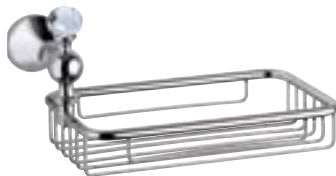

**FS 134**

   **FS .47**

Porta sapone a cestino in ottone  
 Basket soap holder in brass  
 Porte-savon à panier en laiton  
 Seifenhalterkörbchen für Dusche aus Messing  
 Мыльница в ванную, подвесная, сетчатая, латунная

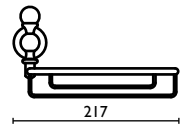
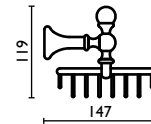

**FS 143**

   **RI .11; FS .47**

Porta bicchiere in vetro satinato  
 Tumbler holder in satin glass  
 Porte-verre en verre dépoli  
 Wand-Becherhalter aus Satiniertglas  
 Стакан, настенный, из матового стекла

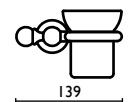
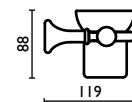

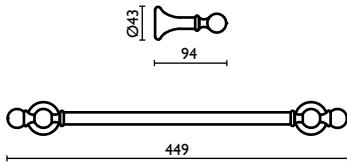

**FS 210**



Porta salvietta 30 cm.  
Towel rail 30 cm.  
Porte-serviette 30 cm.  
Handtuchhalter 30 cm.  
Держатель для полотенец, 30 см.

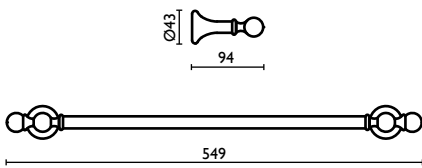

**FS 211**



Porta salvietta 40 cm.  
Towel rail 40 cm.  
Porte-serviette 40 cm.  
Handtuchhalter 40 cm.  
Держатель для полотенец, 40 см.

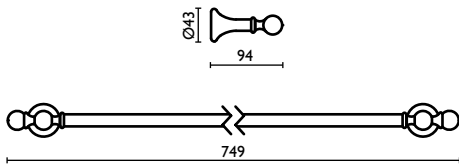

**FS 212**



Porta salvietta 60 cm.  
Towel rail 60 cm.  
Porte-serviette 60 cm.  
Handtuchhalter 60 cm.  
Держатель для полотенец, 60 см.

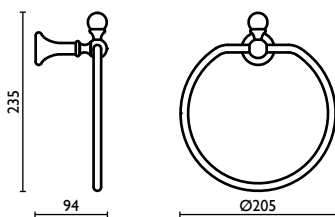

**FS 213**



Porta salvietta ad anello  
Towel ring  
Anneau porte-serviette  
Kreisförmiger Wand-Handtuchhalter  
Держатель для полотенец, кольцом





**FS 214**



Porta salvietta a snodo  
Swivel towel rail  
Porte-serviette mobile  
Schwenkbar-Handtuchhalter

Держатель для полотенец, двойной, поворотный

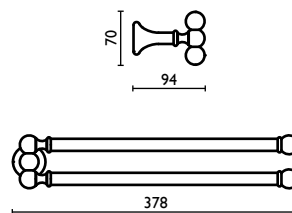

**FS 216**



Porta salvietta doppio 40 cm.  
Double towel rail 40 cm.  
Porte-serviette double 40 cm.  
Doppelt-Handtuchhalter 40 cm.

Держатель для полотенец, двойной, 40 см.

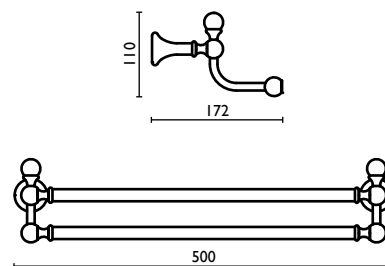

**FS 217**



Porta salvietta doppio 60 cm.  
Double towel rail 60 cm.  
Porte-serviette double 60 cm.  
Doppelt-Handtuchhalter 60 cm.

Держатель для полотенец, двойной, 60 см.

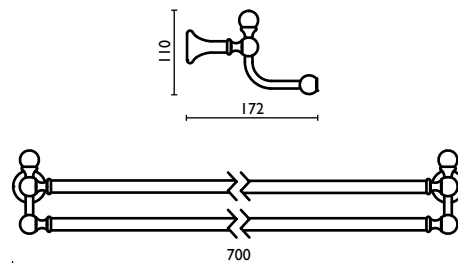

**FS 221**



Porta scopino in ottone  
Toilet brush holder in brass  
Porte-balai en laiton  
Wand-Toilettenbürsten-Garnitur aus Messing

Ершик для туалета, подвесной, латунный

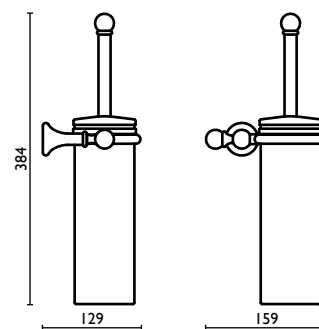

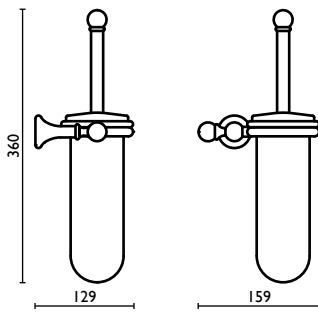

**FS 223**



Porta scopino in vetro satinato  
 Toilet brush holder in satin glass  
 Porte-balai en verre dépoli  
 Satiniert Glas-Wand-Toilettenbürsten-Garnitur  
 Ершик для туалета, подвесной, из матового стекла

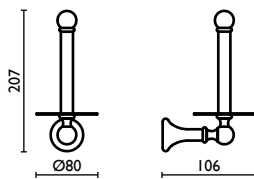

**FS 234**



Porta rotolo di scorta  
 Reserve toilet roll holder  
 Porte-papier de rechange  
 Wand-Ersatzrollenhalter  
 Бумагодержатель запасного рулона

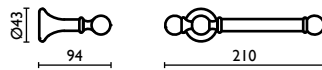

**FS 235**



Porta rotolo  
 Toilet roll holder  
 Porte-papier  
 Wand-Papierrollenhalter  
 Бумагодержатель без крышки

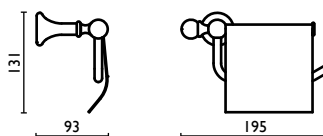

**FS 236**



Porta rotolo coperto  
 Covered toilet roll holder  
 Porte-papier couvert  
 Wand-Papierrollenhalter mit Deckel  
 Бумагодержатель с крышкой





**FS 238**



RI .03: FS .47

Porta salvietta e sapone in vetro satinato

Towel rail and soap holder in satin glass

Porte-serviette avec porte-savon en verre dépoli

Handtuchhalter mit SatiniertGlas-Seifenhalter

Полотенцедержатель с мыльницей из матового стекла, настенный

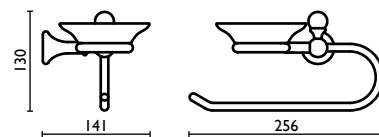

**FS 241**



FS .47

Appendino

Hook

Porte-peignoir

Wand-Kleiderhaken

Крючок одинарный

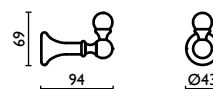

**FS 247**



FS .47

Appendino doppio

Double hook

Porte-peignoir double

Doppelt-Wand-Kleiderhaken

Крючок двойной

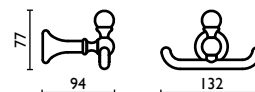

**FS 253**



RI .27; FS .47

Porta scopino d'appoggio in ottone

Standing toilet brush holder in brass

Porte-balai à poser en laiton

Stand-Toilettenbürsten-Garnitur aus Messing

Ершик для туалета, напольный, латунный

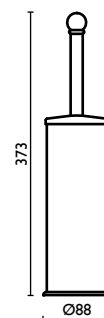

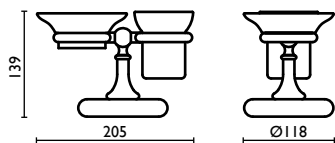

**FS 773**



RI .03; RI .11; FS .47

Porta sapone e bicchiere d'appoggio in vetro satinato

Standing soap and tumbler holder in satin glass

Porte-savon et verre à poser en verre dépoli

Stand-Becher-und Seifenhalter aus Satiniertglas

Держатель мыльницы и стакана из матового стекла, настольный

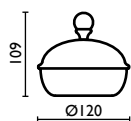

**FS 863**



FS .47

Contenitore Ø12 cm.

Pot Ø12 cm.

Récipient Ø12 cm.

Behälter ø12 cm.

Контейнер ø12 см.

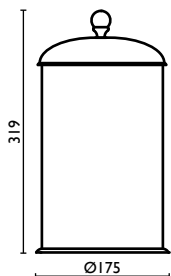

**FS 915**



FS .47

Bidoncino per carta 5 Lt.

Waste bin 5 Lt.

Poubelle 5 Lt.

Mülleimer 5 Lt.

Ведро мусорное для ванной комнаты, объём 5 л

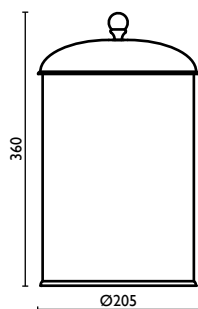

**FS 916**



FS .47

Bidoncino per carta 8 Lt.

Waste bin 8 Lt.

Poubelle 8 Lt.

Mülleimer 8 Lt.

Ведро мусорное для ванной комнаты, объём 8 л

